



# Cambridge IGCSE™

---

## BIOLOGY

1522/12

Paper 1 Multiple Choice (Core)

May/June 2021

45 minutes

You must answer on the multiple choice answer sheet.

You will need: Multiple choice answer sheet  
Soft clean eraser  
Soft pencil (type B or HB is recommended)

---

## INSTRUCTIONS

- There are **forty** questions on this paper. Answer **all** questions.
- For each question there are four possible answers **A, B, C** and **D**. Choose the **one** you consider correct and record your choice in soft pencil on the multiple choice answer sheet.
- Follow the instructions on the multiple choice answer sheet.
- Write in soft pencil.
- Write your name, centre number and candidate number on the multiple choice answer sheet in the spaces provided unless this has been done for you.
- Do **not** use correction fluid.
- Do **not** write on any bar codes.
- You may use a calculator.

## INFORMATION

- The total mark for this paper is 40.
- Each correct answer will score one mark.
- Any rough working should be done on this question paper.

---

This document has **16** pages.



- 1 Which characteristic of living organisms is the taking in of materials for energy, growth and development?
- A respiration  
B nutrition  
C excretion  
D reproduction
- 2 Which pair of plant species belong to the same genus?
- A *Callisia repens* and *Juncus bulbosus*  
B *Juncus bulbosus* and *Ranunculus bulbosus*  
C *Callisia repens* and *Ranunculus repens*  
D *Ranunculus bulbosus* and *Ranunculus repens*
- 3 The diagram shows an arthropod.

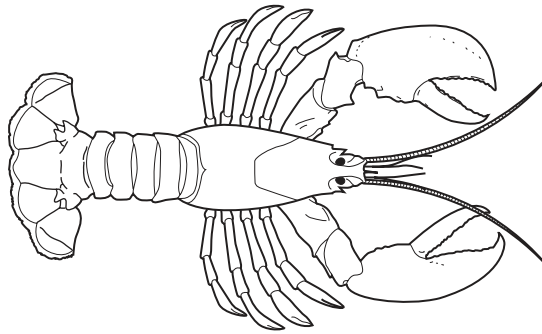

To which group of arthropods does this organism belong?

- A arachnids  
B crustaceans  
C insects  
D myriapods
- 4 Which row shows the structures found in a root hair cell?

	nucleus	cell membrane	cell wall	chloroplast	vacuole
A	✓	x	✓	x	x
B	✓	✓	✓	x	✓
C	x	✓	x	✓	x
D	x	x	x	✓	✓

key

✓ = present

x = not present

- 5 A student draws a diagram of a plant cell.

The diagram is 60 mm wide. The actual plant cell is 0.03 mm wide.

What is the magnification of the diagram?

- A**  $\times 1.8$       **B**  $\times 18$       **C**  $\times 200$       **D**  $\times 2000$

- 6 The apparatus shown was set up.

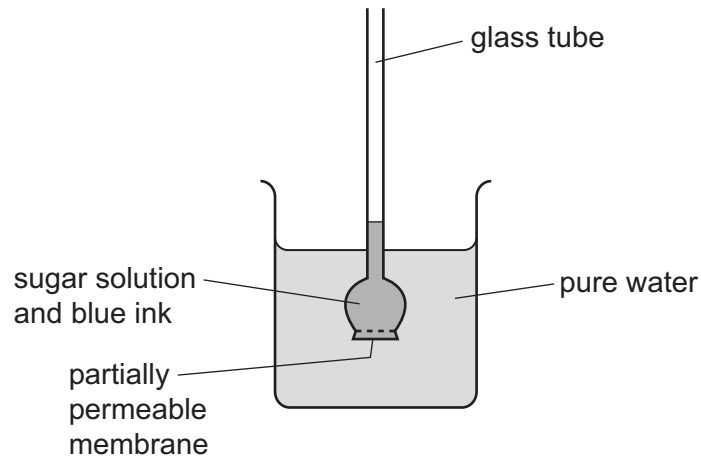

A few hours later, the water in the beaker had turned blue, and the liquid in the glass tube had moved upwards.

Which processes caused these changes?

	water in the beaker turned blue	liquid in the glass tube moved upwards
<b>A</b>	osmosis	diffusion
<b>B</b>	active transport	osmosis
<b>C</b>	diffusion	active transport
<b>D</b>	diffusion	osmosis

- 7 The bar chart shows the concentration of magnesium ions in the soil and in a plant root.

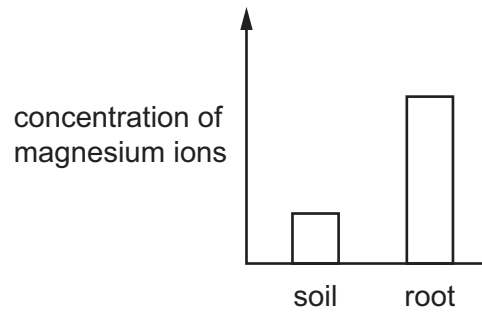

Which process will move magnesium ions from the soil into the root?

- A active transport
  - B diffusion
  - C osmosis
  - D transpiration
- 8 Which element is found in proteins but is absent from fats?
- A carbon
  - B hydrogen
  - C nitrogen
  - D oxygen
- 9 The rate of reaction of an enzyme at different pH values was investigated. The graph shows the results of the investigation.

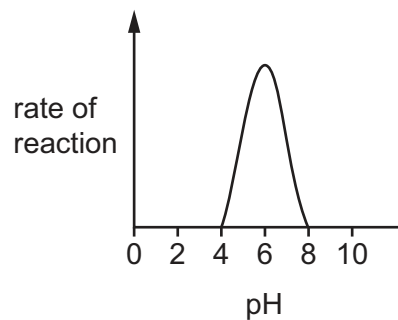

At which pH is the enzyme most active?

- A pH2
- B pH6
- C pH8
- D pH11

10 Which type of molecule are enzymes made of?

- A protein
- B carbohydrate
- C DNA
- D fat

11 A well-watered plant was kept in the dark for 48 hours. A piece of card, with a shape cut out, was then attached to one green leaf. The plant was left in bright sunlight for a day. At the end of the day the whole leaf was tested for the presence of starch.

The diagram shows the result of the starch test.

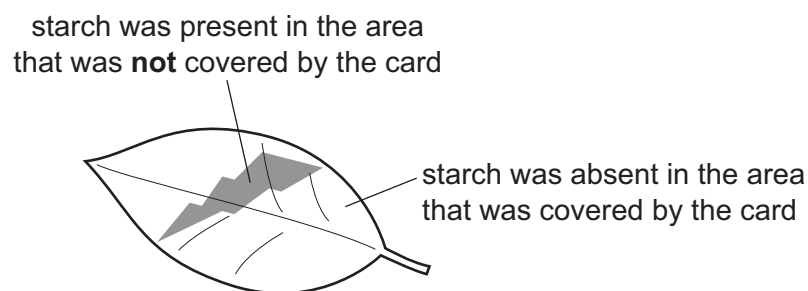

Which factor does this investigation show is necessary for photosynthesis?

- A carbon dioxide
- B chlorophyll
- C light
- D water

12 The mineral ions present in four different soils are shown.

Which soil would be best for growing healthy, green plants?

	nitrate ions	magnesium ions
<b>A</b>	absent	absent
<b>B</b>	absent	present
<b>C</b>	present	absent
<b>D</b>	present	present

13 Some of the nutrients that form part of a balanced diet are listed.

- 1 calcium
- 2 fat
- 3 fibre
- 4 vitamin D

Which nutrients are needed for healthy bones?

- A** 1 and 3      **B** 1 and 4      **C** 2 and 3      **D** 2 and 4

14 Which description of assimilation is correct?

- A** the taking of food and drink into the body through the mouth
- B** the movement of digested food molecules into the cells of the body where they are used and become part of the cells
- C** the movement of soluble molecules into the blood
- D** the passing out of food that has not been digested or absorbed, as faeces, through the anus

15 The diagram shows the alimentary canal and associated organs.

In which part of the alimentary canal is most water absorbed?

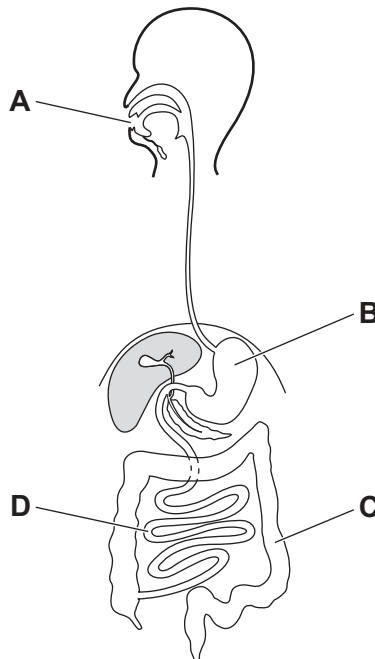

16 The diagram shows a section through the stem of a plant.

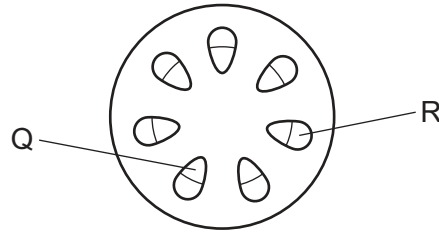

Which row shows the positions and functions of the xylem and phloem?

	position		function	
	xylem	phloem	xylem	phloem
<b>A</b>	Q	R	transports water	transports sugars
<b>B</b>	Q	R	transports sugars	transports water
<b>C</b>	R	Q	transports water	transports sugars
<b>D</b>	R	Q	transports sugars	transports water

17 Which sequence describes the pathway of water as it moves from the soil, through a plant?

- A** root hair cells → xylem → root cortex cells → mesophyll cells → stomata
- B** root cortex cells → root hair cells → xylem → stomata → mesophyll cells
- C** root hair cells → root cortex cells → xylem → mesophyll cells → stomata
- D** root cortex cells → root hair cells → xylem → stomata → mesophyll cells

18 The diagram shows a cross-section through a heart.

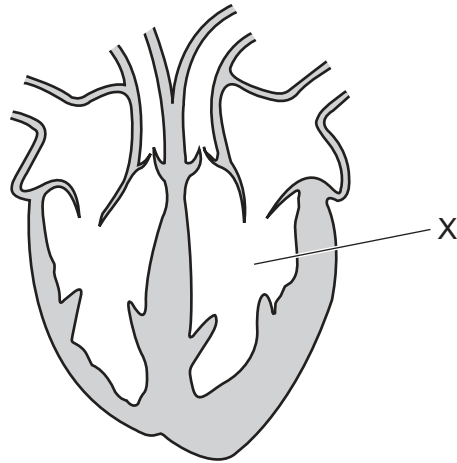

What is the name of the heart chamber labelled X?

- A left atrium
- B left ventricle
- C right atrium
- D right ventricle

19 The diagram shows a pair of human kidneys.

Which letter shows a renal vein?

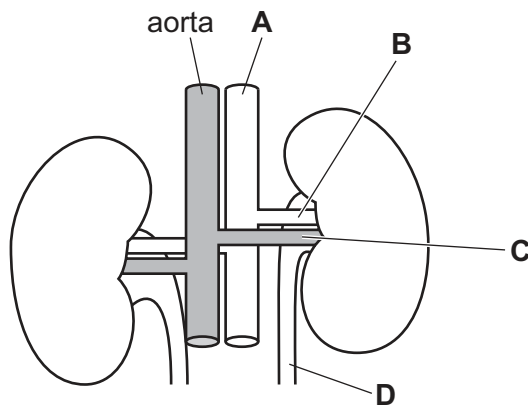



20 The body has different types of defences against pathogens. The list shows some of these defences.

- 1 antibodies
- 2 hairs in the nose
- 3 mucus
- 4 skin

Which defences help to prevent pathogens reaching the alveoli when breathing in?

- A** 1, 2 and 3      **B** 2, 3 and 4      **C** 2 and 3 only      **D** 2 only

21 Which features are present in gas exchange surfaces?

	large surface area	good blood supply	thick walls
<b>A</b>	✓	✓	x
<b>B</b>	✓	x	✓
<b>C</b>	x	✓	✓
<b>D</b>	✓	✓	✓

key

✓ = present

x = not present

22 A student exercised for three minutes. Before exercise, her breathing rate was 15 breaths per minute. During exercise, her breathing rate was 45 breaths per minute.

What is the percentage increase in her breathing rate?

- A** 33%      **B** 67%      **C** 200%      **D** 300%

23 Which row is correct for anaerobic respiration?

	energy released	oxygen required	waste products
<b>A</b>	a little	no	lactic acid
<b>B</b>	a little	yes	carbon dioxide and water
<b>C</b>	a lot	no	lactic acid
<b>D</b>	a lot	yes	carbon dioxide and water

24 Which food type, when eaten in excess, will cause a rise in the urea content of urine?

- A carbohydrate
- B fat
- C mineral salts
- D protein

25 The diagram shows a simple reflex arc.

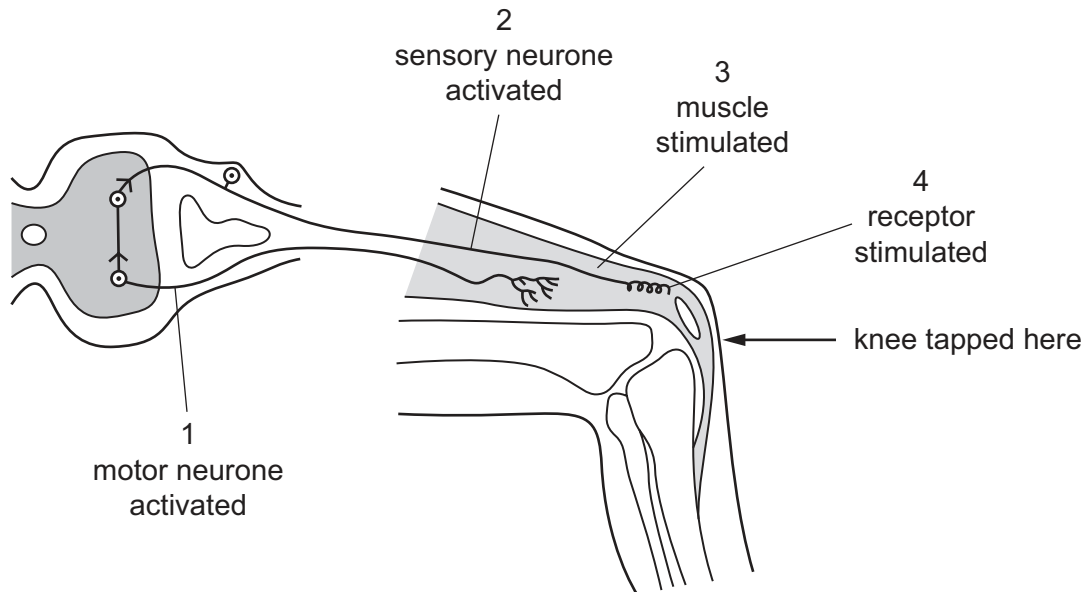

What is the correct order of events after the knee is tapped?

- A 1 → 2 → 3 → 4
- B 1 → 4 → 2 → 3
- C 4 → 2 → 1 → 3
- D 4 → 3 → 2 → 1

26 The diagram shows some of the structures found in the skin.

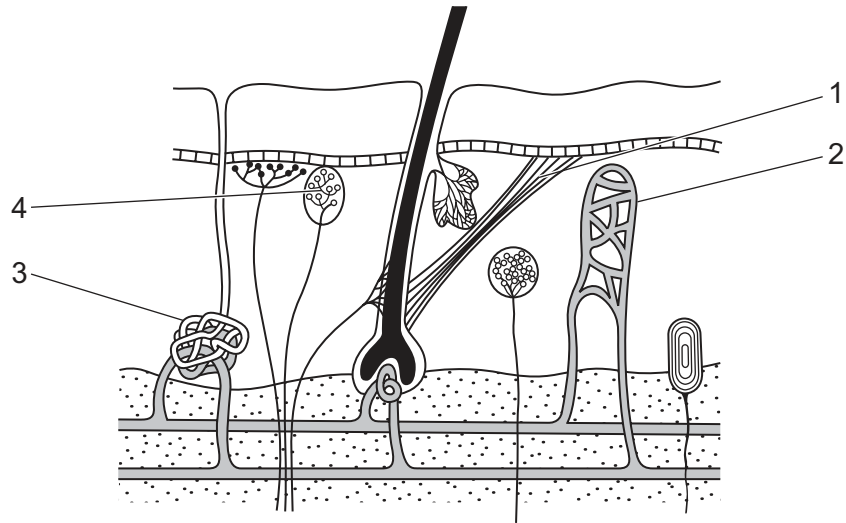

Which labels identify a blood vessel, a receptor and a sweat gland?

	blood vessel	receptor	sweat gland
<b>A</b>	3	2	4
<b>B</b>	2	4	3
<b>C</b>	3	1	2
<b>D</b>	2	3	1

27 The diagram shows a seedling, fixed to a rotating platform. Light is directed from one side only.

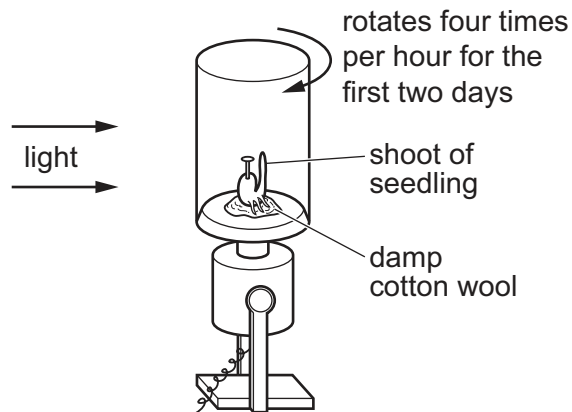

The platform was allowed to rotate for two days. The rotation was stopped and the apparatus remained still for a further two days.

Which diagram shows the appearance of the seedling after this four-day period?

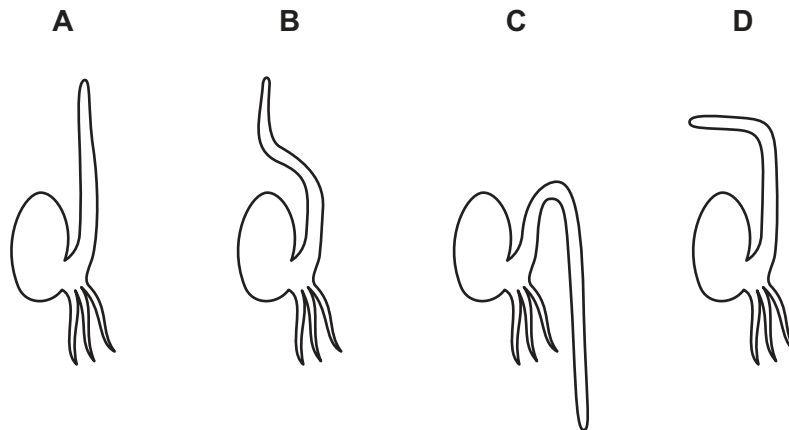

28 Alcohol is a drug.

Which statement is correct?

- A It can cause COPD.
- B It is a depressant.
- C It is not addictive.
- D It reduces reaction times.

29 The diagram shows a form of reproduction in a yeast cell.

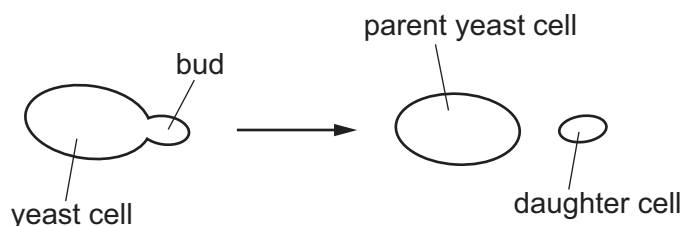

The yeast cell creates a bud on one side of the cell which will eventually separate to form a new daughter cell.

Which statement is correct?

- A Two parents are required for this type of reproduction.
  - B The daughter cell is genetically identical to the parent cell.
  - C This is an example of sexual reproduction.
  - D The fusion of gametes is required for this type of reproduction.
- 30 What is the sequence of development that produces a fetus?
- A embryo → gametes → zygote
  - B embryo → zygote → gametes
  - C gametes → embryo → zygote
  - D gametes → zygote → embryo

31 The graph shows the changes in the thickness of the uterus lining during a menstrual cycle.

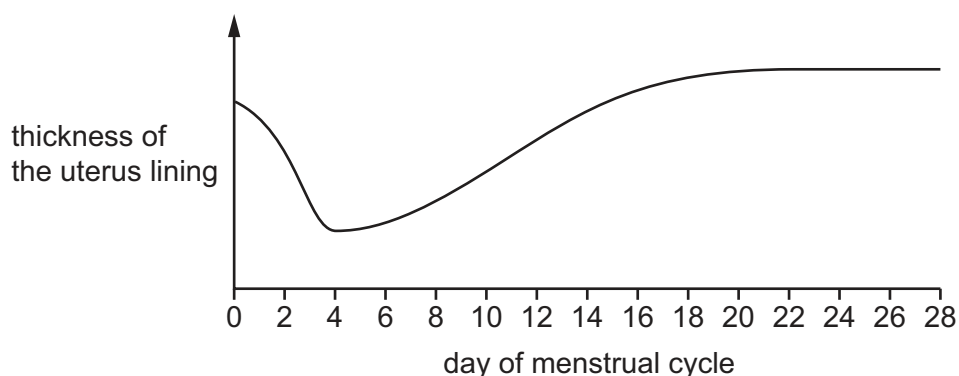

When does the graph show menstruation occurring?

- A day 14
- B days 14–28
- C days 6–28
- D days 0–4

32 What determines the sex of a baby?

- A the father's XX chromosomes
- B the father's XY chromosomes
- C the mother's XX chromosomes
- D the mother's XY chromosomes

33 The diagram shows the genotypes of two parent plants and three of their offspring for a characteristic that is controlled by a dominant allele, R.

parents	plant 1		plant 2
	Rr		Rr
offspring	plant 3	plant 4	plant 5
	RR	Rr	rr

Which plants have the same phenotype for this characteristic?

- A 1, 2, 3 and 4
  - B 1, 2 and 4 only
  - C 3, 4 and 5
  - D 3 and 5 only
- 34 Which human characteristic is an example of discontinuous variation?
- A height
  - B skin colour
  - C sex
  - D weight

35 The diagram shows a simple food web in a desert habitat.

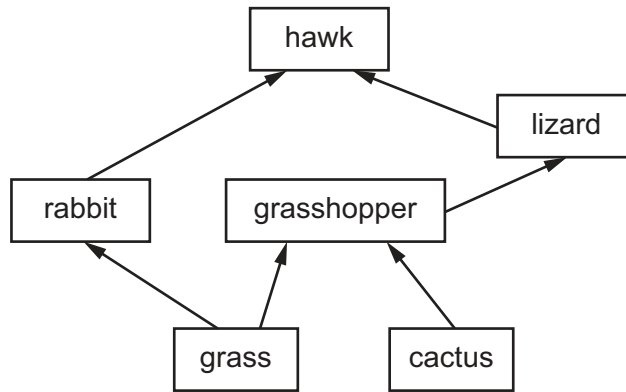

Which food chain can be found in this web?

- A cactus → grasshopper → grass
  - B grass → grasshopper → lizard
  - C hawk → lizard → grasshopper
  - D rabbit → hawk → lizard
- 36 What is the principal source of energy input into most biological systems?
- A photosynthesis
  - B the Sun
  - C carbon dioxide
  - D respiration
- 37 Which process is part of the carbon cycle?
- A combustion
  - B evaporation
  - C precipitation
  - D transpiration
- 38 What do biological washing powders contain?
- A bacteria
  - B enzymes
  - C herbicides
  - D vitamins

39 Which hormone reduces the concentration of glucose in the blood?

- A adrenaline
- B insulin
- C oestrogen
- D testosterone

40 The graph shows the percentage of different waste products that were recycled between 1980 and 2010.

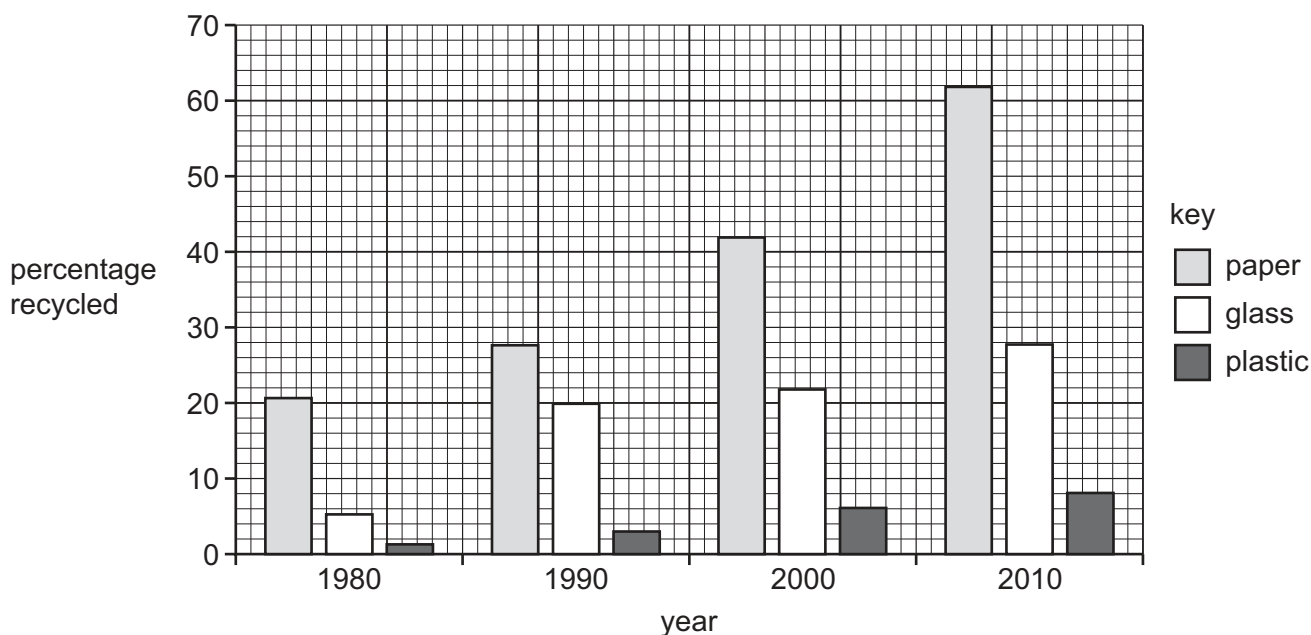

Which statements about the recycling shown in the graph are correct?

- 1 Plastic is recycled the least in each year shown.
- 2 The percentage of each product recycled increases in each year shown.
- 3 Paper is the product that is recycled the most in each year shown.

- A** 1, 2 and 3    **B** 1 and 2 only    **C** 1 and 3 only    **D** 2 and 3 only

Permission to reproduce items where third-party owned material protected by copyright is included has been sought and cleared where possible. Every reasonable effort has been made by the publisher (UCLES) to trace copyright holders, but if any items requiring clearance have unwittingly been included, the publisher will be pleased to make amends at the earliest possible opportunity.

To avoid the issue of disclosure of answer-related information to candidates, all copyright acknowledgements are reproduced online in the Cambridge Assessment International Education Copyright Acknowledgements Booklet. This is produced for each series of examinations and is freely available to download at [www.cambridgeinternational.org](http://www.cambridgeinternational.org) after the live examination series.

Cambridge Assessment International Education is part of the Cambridge Assessment Group. Cambridge Assessment is the brand name of the University of Cambridge Local Examinations Syndicate (UCLES), which itself is a department of the University of Cambridge.